

B

VS 10-75 CG uPC
VS 40-150 CG uPC SUP-EXH
VS 180-300 CG uPC
VS 400-650 CG uPC

APPLICATION: AD2056

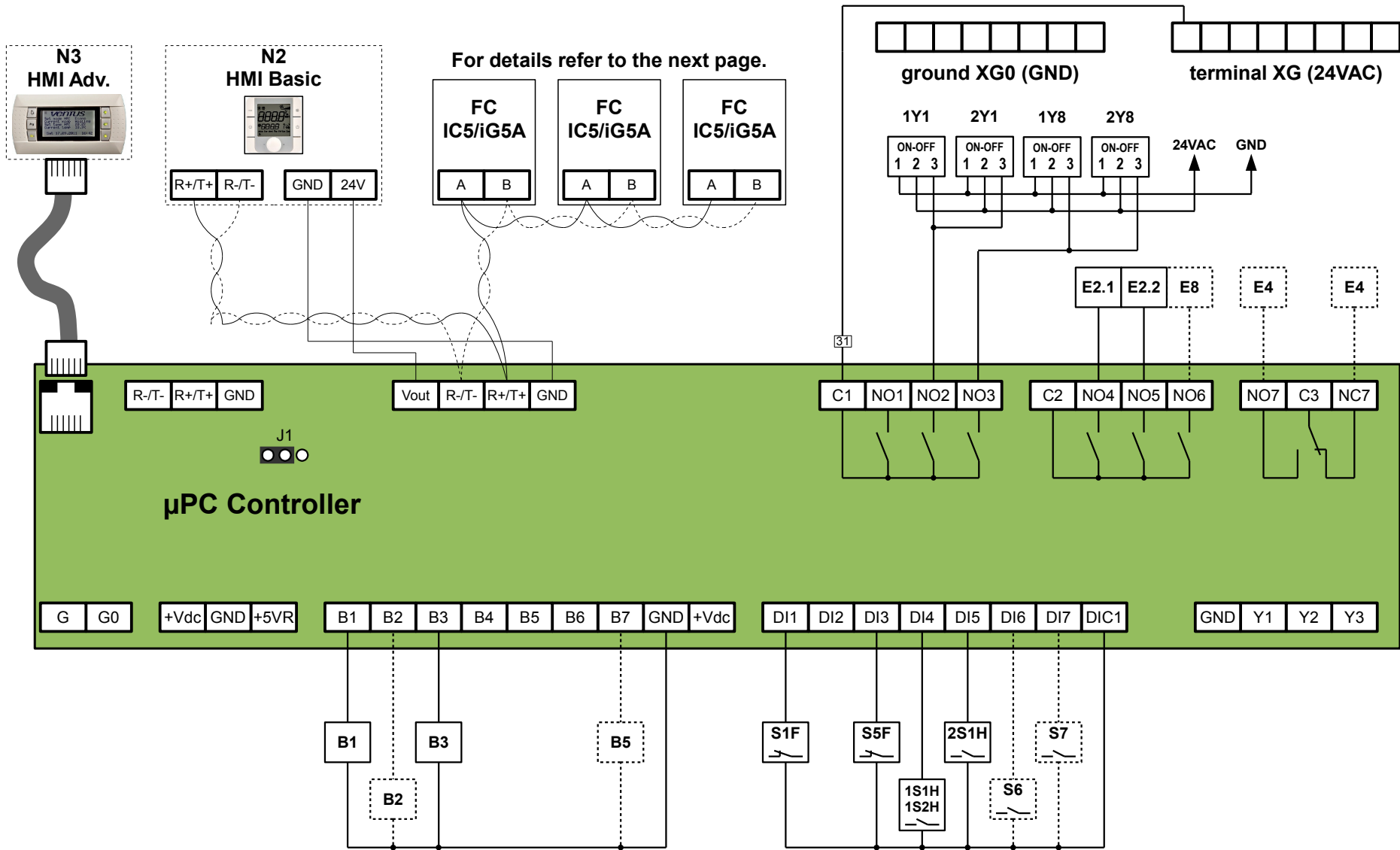

B

MODBUS CONNECTION



SENSOR B2

	HMI Basic uPC = YES	HMI Basic uPC = NO
App.Code A...-S	✗	✗
App.Code A...-R	✗	B2 ✓
App.Code A...-E	B2 ✓	B2 ✓